



e~~x~~terrain

4x4 & Lighting and Accessories



The team at eXterrain believe it is important to have the right vehicle, accessories and outdoor equipment. eXterrain is an established company bringing forward a new vision for 4WD lighting products within Australia - without compromising affordability and reliability.

eXterrain products are based on thorough research and have endured stringent testing. We pride ourselves on the quality of our products and ensure great value and service.

Proudly Australian owned and operated, eXterrain distribute 4WD Lighting and Lighting accessories.

Follow us on social media



X RAVEN S

Slim Single Row Light Bars



eXterrain's Raven Super Slim Single Row bar light series are ideal for 4WD and truck installation. These lights have a combo beam of 10°+ 40° and range from 30-90 Watt LED power creating a powerfully bright output for off road conditions. It's unique ultra slim chassis is striking in appearance and suitable for positions where other bars are unable to fit.

All eXterrain Raven bar lights come with Lifetime Warranty.

RAVEN S 490

490mm/20" 90W LED Power Super Slim Single Row Bar Light



- Combo Beam (10°C+ 40°C)
- 490mm / 20"
- Reverse Polarity Protection
- UV Resistant
- Shock Resistant
- Rust/Corrosion/Freeze Resistant
- Olive Shaped Lens
- Includes Male DT Connector
- Ideal for Cars, 4X4 and Trucks
- LIFETIME WARRANTY
- Voltage: DC10-30V
- Power: 90W (5W x 18) LEDs
- Current: 5.4/2.6A
- Operating Temperature: - 40°C~ 85°C
- Colour Temperature: 6500K
- Luminous Flux: 8500LM
- IP68 Waterproof
- Dimensions: 494 x 26 x 51 (mm)
- Lens: Lexan PC Shatterproof Front Cover
- Chassis: Die-cast Aluminium Alloy
- Finish: Anodised Polyester Powder Coating

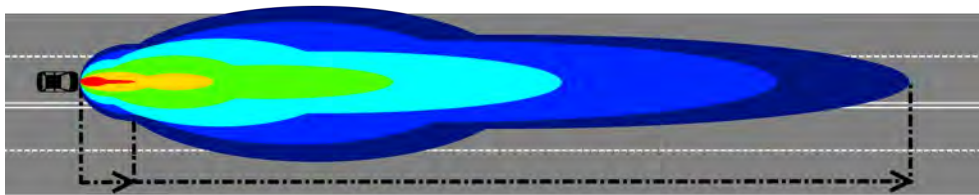

1980 LUX
10m

1 LUX
460m

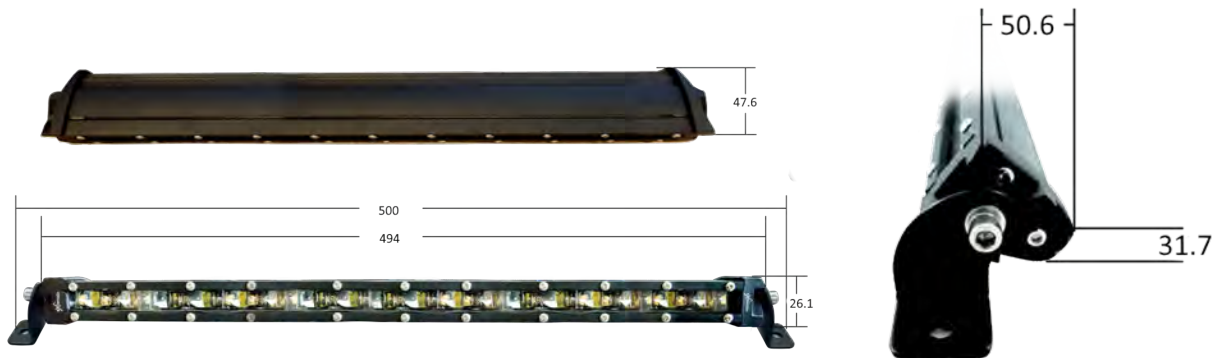

RAVEN S 340

340mm/14" 60W LED Power Super Slim Single Row Bar Light



- Combo Beam (10°C+ 40°C)
- 340 mm / 14"
- Reverse Polarity Protection
- UV Resistant
- Shock Resistant
- Rust/Corrosion/Freeze Resistant
- Olive Shaped Lens
- Includes Male DT Connector
- Ideal for Cars, 4X4 and Trucks
- LIFETIME WARRANTY
- Voltage: DC10-30V
- Power: 60W (5W x 12) LEDs
- Current: 3.6/1.8A
- Operating Temperature: - 40°C~ 85°C
- Colour Temperature: 6500K
- Luminous Flux: 5950LM
- IP68 Waterproof
- Dimensions: 342 x 26 x 51 (mm)
- Lens: Lexan PC Shatterproof Front Cover
- Chassis: Die-cast Aluminium Alloy
- Finish: Anodised Polyester Powder Coating

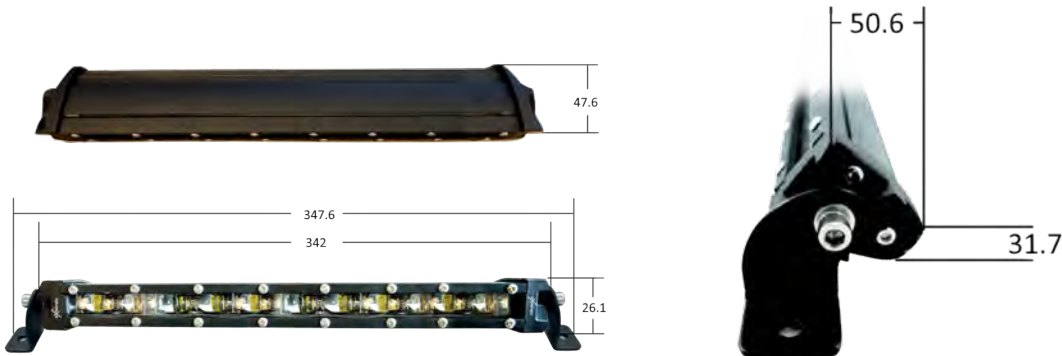
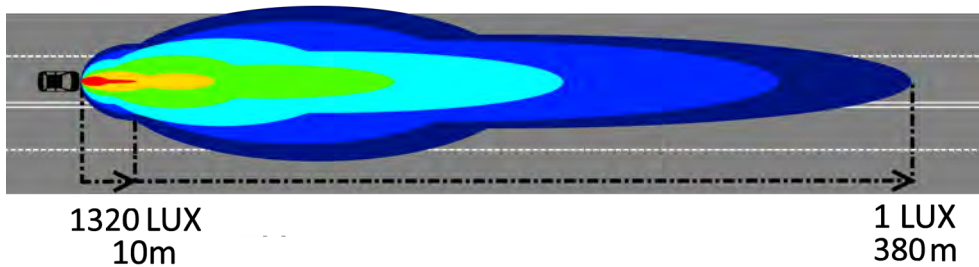

RAVEN S 190

190mm/8" 30W Led Power Super Slim Single Row Bar Light



- Combo Beam (10°C+ 40°C)
- 190 mm / 8"
- Reverse Polarity Protection
- UV Resistant
- Shock Resistant
- Rust/Corrosion/Freeze Resistant
- Olive Shaped Lens
- Includes Male DT Connector
- Ideal for Cars, 4X4 and Trucks
- LIFETIME WARRANTY
- Voltage: DC10-30V
- Power: 30W (5W x 6) LEDs
- Current: 1.8/0.9A
- Operating Temperature: - 40°C~ 85°C
- Colour Temperature: 6500K
- Luminous Flux: 2550LM
- IP68 Waterproof
- Dimensions: 190 x 26 x 51 (mm)
- Lens: Lexan PC Shatterproof Front Cover
- Chassis: Die-cast Aluminium Alloy
- Finish: Anodised Polyester Powder Coating

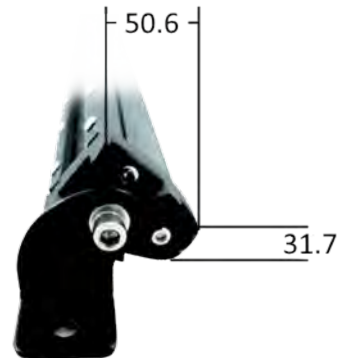
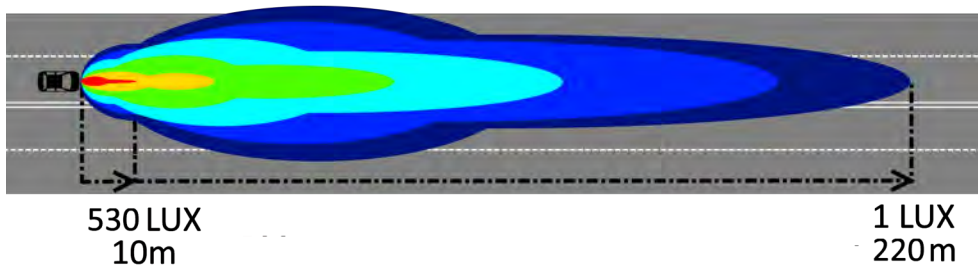

eXterrain

RAVEN SERIES

Slim Dual Row Light Bars



eXterrain's RAVEN Slim Dual Row bar spot light series are ideal for 4WD and truck installation. These lights have a combo beam of 10° and 40° and range from 48 - 300 Watt creating a powerfully bright output for on or off road conditions. With a unique slim chassis, it is striking in appearance especially when compared to other dual row bar lights available within the market.

All eXterrain Raven bar lights come with Lifetime Warranty.

RAVEN 1320: 1320mm/52" 300 Watt

Slim Dual Row Bar Light



- Combo Beam (10°C + 40°C)
- 1320 mm / 52"
- Reverse Polarity Protection
- UV Resistant
- Shock Resistant
- Rust/Corrosion/Freeze Resistant
- Olive Shaped Lens
- Includes Male Round Connector
- Ideal for Cars, 4X4 and Trucks
- LIFETIME WARRANTY
- Voltage: DC10-30V
- Power: 300W (3W x 100) LEDs
- Current: 7/3.5A
- Operating Temperature: - 40°C ~ 85°C
- Colour Temperature: 6500K
- Luminous Flux: 24000LM
- IP68 Waterproof
- Dimensions: 1377 x 82 x 60 (mm)
- Lens: Lexan PC Shatterproof Front Cover
- Chassis: Die-cast Aluminium Alloy
- Finish: Anodised Polyester Powder Coating

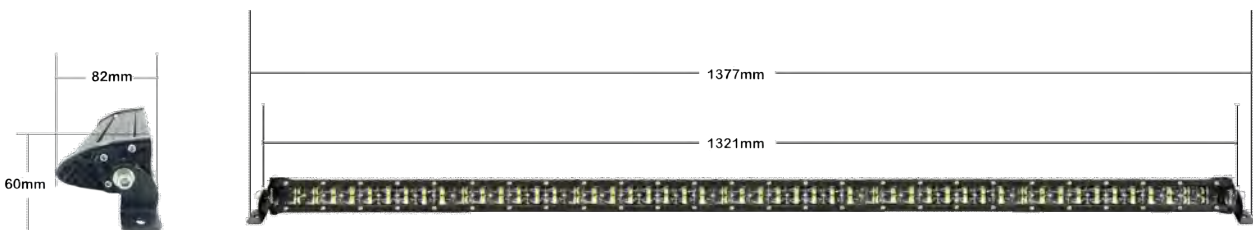
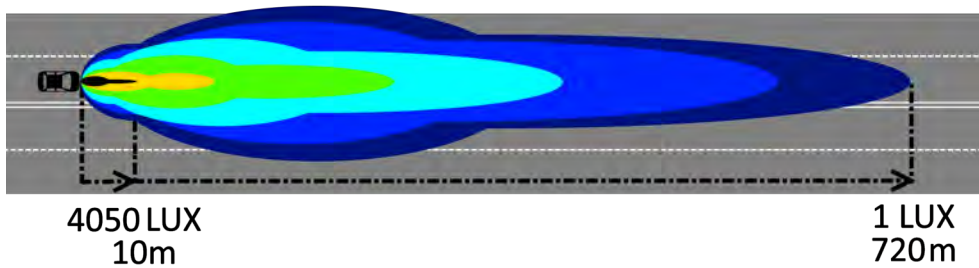

RAVEN1070: 1070mm/42" 240 Watt

Slim Dual Row Bar Light



- Combo Beam (10°C + 40°C)
- 1070 mm / 42"
- Reverse Polarity Protection
- UV Resistant
- Shock Resistant
- Rust/Corrosion/Freeze Resistant
- Olive Shaped Lens
- Includes Male Round Connector
- Ideal for Cars, 4X4 and Trucks
- LIFETIME WARRANTY
- Voltage: DC10-30V
- Power: 240W (3W x 80) LEDs
- Current: 5.6/2.8A
- Operating Temperature: - 40°C ~ 85°C
- Colour Temperature: 6500K
- Luminous Flux: 19200LM
- IP68 Waterproof
- Dimensions: 1123 x 82 x 60 (mm)
- Lens: Lexan PC Shatterproof Front Cover
- Chassis: Die-cast Aluminium Alloy
- Finish: Anodised Polyester Powder Coating

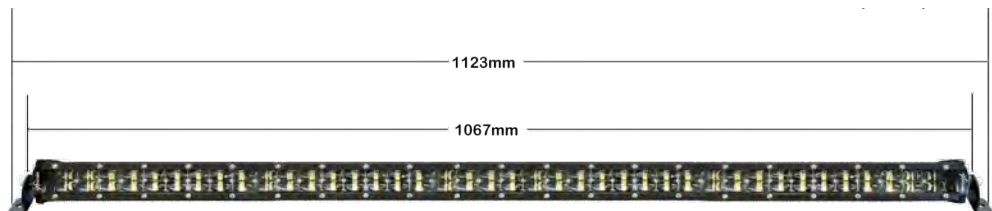
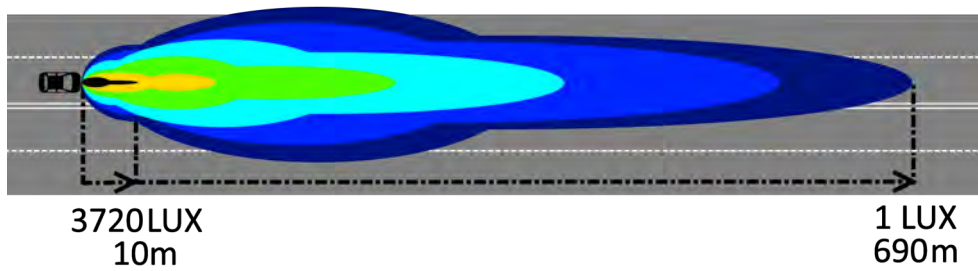

RAVEN810: 810mm/32" 180 Watt

Slim Dual Row Bar Light



- Combo Beam (10°C + 40°C)
- 810 mm / 32"
- Reverse Polarity Protection
- UV Resistant
- Shock Resistant
- Rust/Corrosion/Freeze Resistant
- Olive Shaped Lens
- Includes Male DT Connector
- Ideal for Cars, 4X4 and Trucks
- LIFETIME WARRANTY
- Voltage: DC10-30V
- Power: 180W (3W x 60) LEDs
- Current: 4.2/2.1A
- Operating Temperature: - 40°C ~ 85°C
- Colour Temperature: 6500K
- Luminous Flux: 14400LM
- IP68 Waterproof
- Dimensions: 869 x 82 x 60 (mm)
- Lens: Lexan PC Shatterproof Front Cover
- Chassis: Die-cast Aluminium Alloy
- Finish: Anodised Polyester Powder Coating

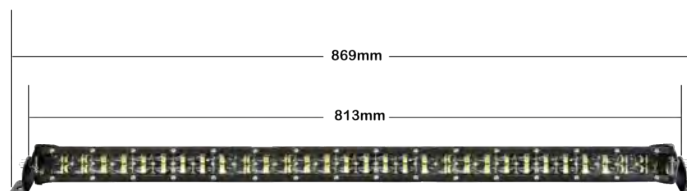
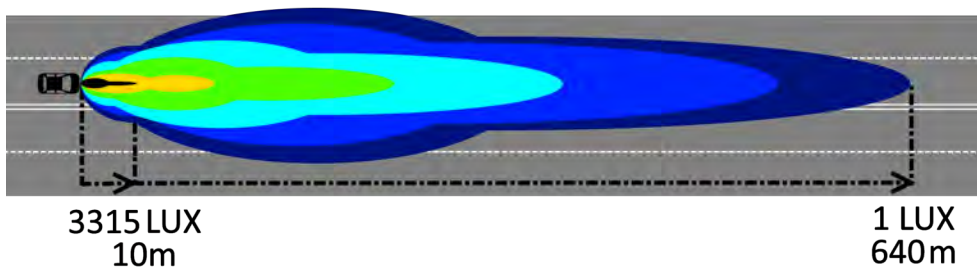

RAVEN560: 560mm/22" 120 Watt

Slim Dual Row Bar Light



- Combo Beam (10°C + 40°C)
- 560 mm / 22"
- Reverse Polarity Protection
- UV Resistant
- Shock Resistant
- Rust/Corrosion/Freeze Resistant
- Olive Shaped Lens
- Includes Male DT Connector
- Ideal for Cars, 4X4 and Trucks
- LIFETIME WARRANTY
- Voltage: DC10-30V
- Power: 120W (3W x 40) LEDs
- Current: 3.2/1.6A
- Operating Temperature: - 40°C ~ 85°C
- Colour Temperature: 6500K
- Luminous Flux: 9600LM
- IP68 Waterproof
- Dimensions: 613 x 82 x 60 (mm)
- Lens: Lexan PC Shatterproof Front Cover
- Chassis: Die-cast Aluminium Alloy
- Finish: Anodised Polyester Powder Coating

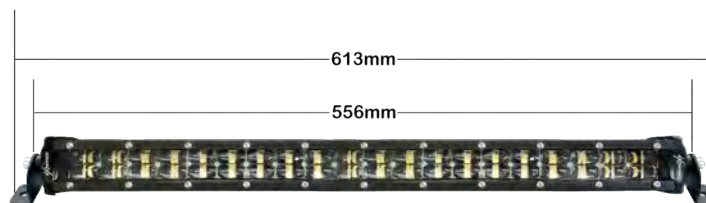
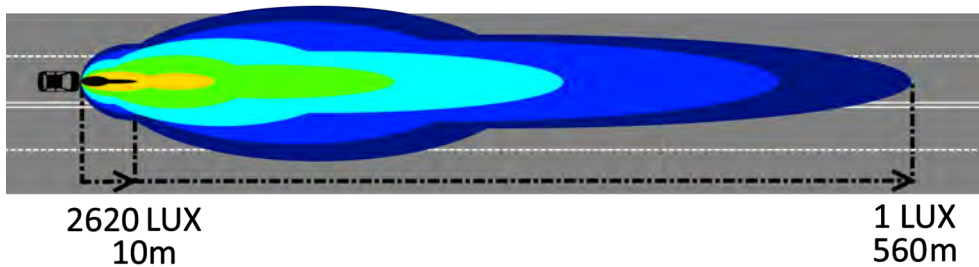

RAVEN350: 350mm/14" 72 Watt

Slim Dual Row Bar Light



- Combo Beam (10°C + 40°C)
- 350 mm / 14"
- Reverse Polarity Protection
- UV Resistant
- Shock Resistant
- Rust/Corrosion/Freeze Resistant
- Olive Shaped Lens
- Includes Male DT Connector
- Ideal for Cars, 4X4 and Trucks
- LIFETIME WARRANTY
- Voltage: DC10-30V
- Power: 72W (3W x 24) LEDs
- Current: 2/1A
- Operating Temperature: - 40°C ~ 85°C
- Colour Temperature: 6500K
- Luminous Flux: 5760LM
- IP68 Waterproof
- Dimensions: 412 x 82 x 60 (mm)
- Lens: Lexan PC Shatterproof Front Cover
- Chassis: Die-cast Aluminium Alloy
- Finish: Anodised Polyester Powder Coating

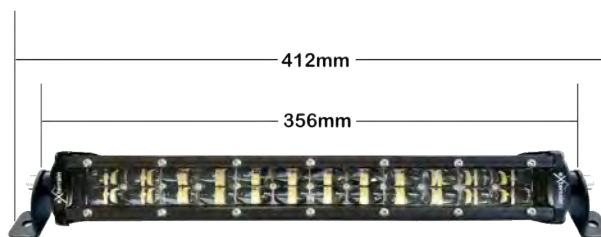
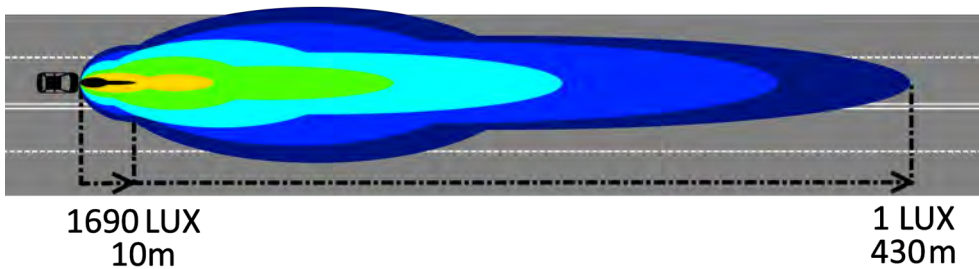

RAVEN240: 240mm/9.5" 48 Watt

Slim Dual Row Bar Light



- Combo Beam (10°C+ 40°C)
- 240 mm / 9.5"
- Reverse Polarity Protection
- UV Resistant
- Shock Resistant
- Rust/Corrosion/Freeze Resistant
- Olive Shaped Lens
- Includes Male DT Connector
- Ideal for Cars, 4X4 and Trucks
- LIFETIME WARRANTY
- Voltage: DC10-30V
- Power: 48W (3W x 16) LEDs
- Current: 1.6/0.8A
- Operating Temperature: - 40°C~ 85°C
- Colour Temperature: 6500K
- Luminous Flux: 3840LM
- IP68 Waterproof
- Dimensions: 297 x 82 x 60 (mm)
- Lens: Lexan PC Shatterproof Front Cover
- Chassis: Die-cast Aluminium Alloy
- Finish: Anodised Polyester Powder Coating

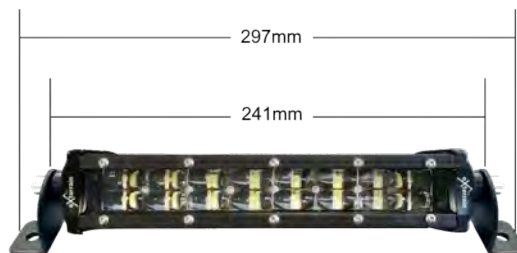
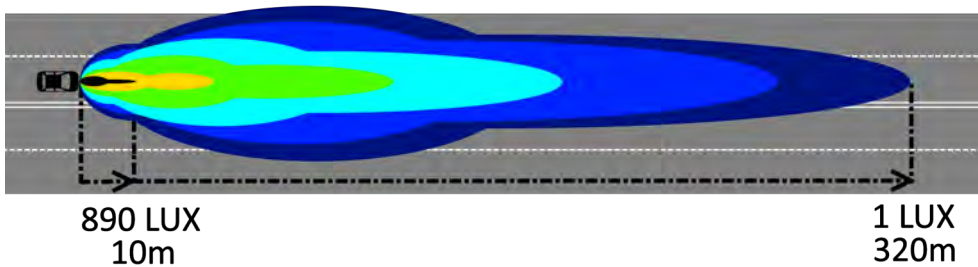



RAVEN



Slim Quad Row Light Bars



eXterrain's Raven Slim Quad Row bar light series are ideal for 4WD and truck installation. These lights have a combo beam of 10°+ 40° and range from 24-576 Watt LED power creating a powerfully bright output for off road conditions that has an extremely narrow profile compared to most quad rows available within the market.

All eXterrain Raven bar lights come with Lifetime Warranty.

RAVEN X 1270 1270mm/50" 576W LED Power Slim Quad Row Bar Light



- Combo Beam (10°C+ 40°C)
- 1270mm / 50"
- Reverse Polarity Protection
- UV Resistant
- Shock Resistant
- Rust/Corrosion/Freeze Resistant
- Olive Shaped Lens
- Includes Male DT Connector
- Ideal for Cars, 4X4 and Trucks
- LIFETIME WARRANTY
- Voltage: DC10-30V
- Power: 576W (3W x 192) LEDs
- Current: 26.8/12.2A
- Operating Temperature: - 40°C~ 85°C
- Colour Temperature: 6500K
- Luminous Flux: 48960LM
- IP68 Waterproof
- Dimensions: 1340 x 82 x 90 (mm)
- Lens: Lexan PC Shatterproof Front Cover
- Chassis: Die-cast Aluminium Alloy
- Finish: Anodised Polyester Powder Coating

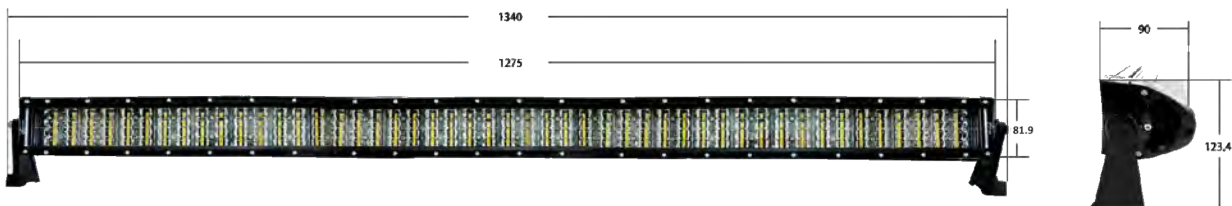
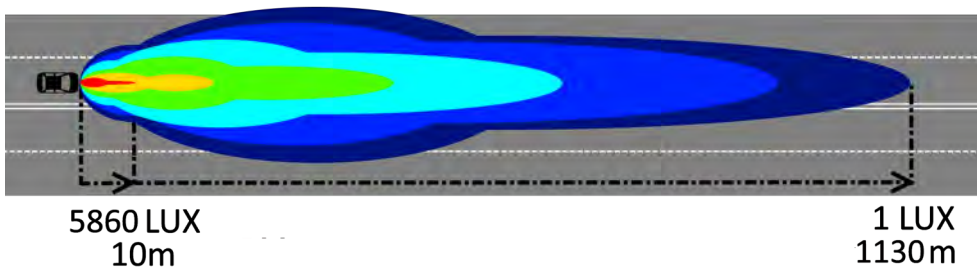

RAVEN X 1070

1070mm/42" 480W LED Power Slim Quad Row Bar Light



- Combo Beam (10°C+ 40°C)
- 1070mm / 42"
- Reverse Polarity Protection
- UV Resistant
- Shock Resistant
- Rust/Corrosion/Freeze Resistant
- Olive Shaped Lens
- Includes Male DT Connector
- Ideal for Cars, 4X4 and Trucks
- LIFETIME WARRANTY
- Voltage: DC10-30V
- Power: 480W (3W x 160) LEDs
- Current: 22.6/10A
- Operating Temperature: - 40°C~ 85°C
- Colour Temperature: 6500K
- Luminous Flux: 40800LM
- IP68 Waterproof
- Dimensions: 1136 x 82 x 90 (mm)
- Lens: Lexan PC Shatterproof Front Cover
- Chassis: Die-cast Aluminium Alloy
- Finish: Anodised Polyester Powder Coating

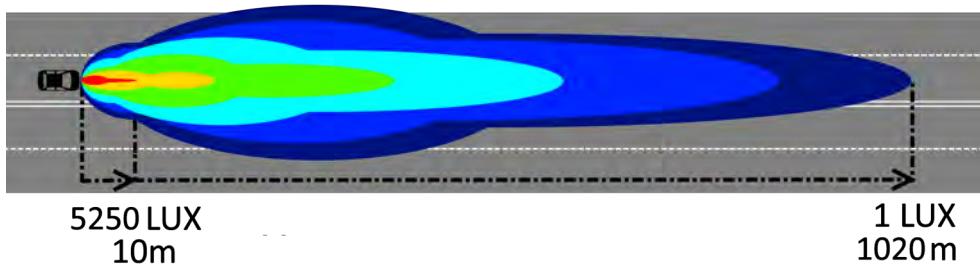

RAVEN X 810

810mm/32" 360W LED Power Slim Quad Row Bar Light



- Combo Beam (10°C+ 40°C)
- 810mm / 32"
- Reverse Polarity Protection
- UV Resistant
- Shock Resistant
- Rust/Corrosion/Freeze Resistant
- Olive Shaped Lens
- Includes Male DT Connector
- Ideal for Cars, 4X4 and Trucks
- LIFETIME WARRANTY
- Voltage: DC10-30V
- Power: 360W (3W x 120) LEDs
- Current: 16.9/7.5A
- Operating Temperature: - 40°C~ 85°C
- Colour Temperature: 6500K
- Luminous Flux: 30600LM
- IP68 Waterproof
- Dimensions: 881 x 82 x 90 (mm)
- Lens: Lexan PC Shatterproof Front Cover
- Chassis: Die-cast Aluminium Alloy
- Finish: Anodised Polyester Powder Coating

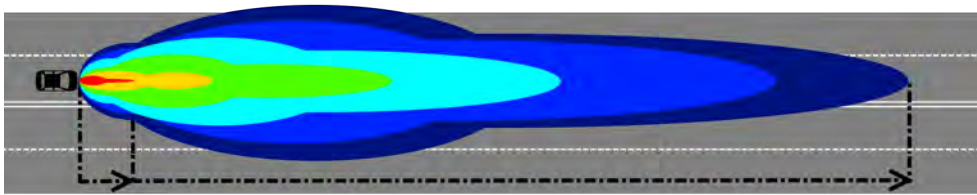

4680 LUX
10m

1 LUX
850m

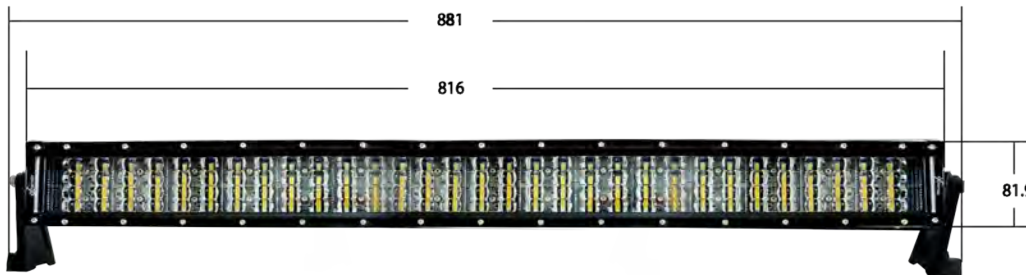

RAVEN X 560

560mm/22" 240W LED Power Slim Quad Row Bar Light



- Combo Beam (10°C+ 40°C)
- 560mm / 22"
- Reverse Polarity Protection
- UV Resistant
- Shock Resistant
- Rust/Corrosion/Freeze Resistant
- Olive Shaped Lens
- Includes Male DT Connector
- Ideal for Cars, 4X4 and Trucks
- LIFETIME WARRANTY
- Voltage: DC10-30V
- Power: 240W (3W x 80) LEDs
- Current: 11.8/5A
- Operating Temperature: - 40°C~ 85°C
- Colour Temperature: 6500K
- Luminous Flux: 20400LM
- IP68 Waterproof
- Dimensions: 626 x 82 x 90 (mm)
- Lens: Lexan PC Shatterproof Front Cover
- Chassis: Die-cast Aluminium Alloy
- Finish: Anodised Polyester Powder Coating

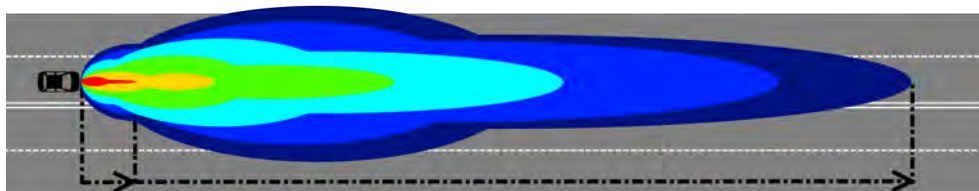

3720 LUX
10m

1 LUX
690m



RAVEN X 80

80mm/3.2" 24W LED Power Slim Quad Row Pod Light



- Combo Beam (10°C+ 40°C)
- 80mm / 3.2"
- Reverse Polarity Protection
- UV Resistant
- Shock Resistant
- Rust/Corrosion/Freeze Resistant
- Olive Shaped Lens
- Includes Male DT Connector
- Ideal for Cars, 4X4 and Trucks
- LIFETIME WARRANTY

Note: RavenX80 can also be sold as a pack—RavenX80RVP

- Voltage: DC10-30V
- Power: 24W (3W x 8) LEDs
- Current: 1.02/.55A
- Operating Temperature: - 40°C~ 85°C
- Colour Temperature: 6500K
- Luminous Flux: 2040LM
- IP68 Waterproof
- Dimensions: 82 x 76 x 82 (mm)
- Lens: Lexan PC Shatterproof Front Cover
- Chassis: Die-cast Aluminium Alloy
- Finish: Anodised Polyester Powder Coating



X CONDOR

Single Square Row Light Bars



eXterrain's Condor Single Square Row bar light series are ideal for 4WD and truck installation. These lights have a spot beam of 45° and range from 30-90 Watt LED power - creating a powerfully bright output over a large area.

All eXterrain Raven bar lights come with Lifetime Warranty.

CONDOR750 750mm/30" 90W LED Power

Single Square Row Bar Light



- Spot Beam (45°)
- 750mm / 30"
- Reverse Polarity Protection
- UV Resistant
- Rust/Corrosion/Freeze Resistant
- Olive Shaped Lens
- Includes Male DT Connector
- Ideal for Cars, 4X4 and Trucks
- LIFETIME WARRANTY
- Voltage: DC10-30V
- Power: 90W (5W x 18) LEDs
- Current: 5.4/2.6A
- Operating Temperature: - 40°C~ 85°C
- Colour Temperature: 6500K
- Luminous Flux: 8500LM
- IP68 Waterproof
- Dimensions: 755 x 55 x 46 (mm)
- Lens: Lexan PC Shatterproof Front Cover
- Chassis: Die-cast Aluminium Alloy
- Finish: Anodised Polyester Powder Coating

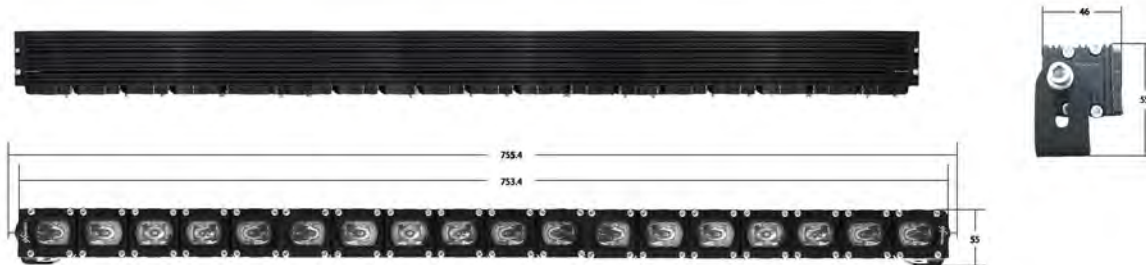
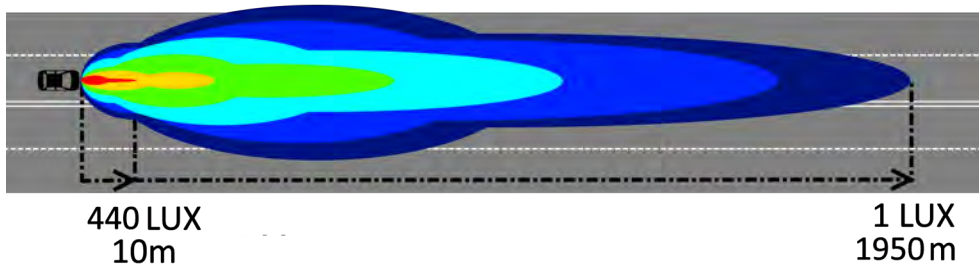



CONDOR510 510mm/20" 30W LED Power

Single Square Row Bar Light



- Spot Beam (45°C)
- 510mm / 20"
- Reverse Polarity Protection
- UV Resistant
- Rust/Corrosion/Freeze Resistant
- Olive Shaped Lens
- Includes Male DT Connector
- Ideal for Cars, 4X4 and Trucks
- LIFETIME WARRANTY
- Voltage: DC10-30V
- Power: 60W (5W x 12) LEDs
- Current: 3.6/1.8A
- Operating Temperature: - 40°C~ 85°C
- Colour Temperature: 6500K
- Luminous Flux: 5950LM
- IP68 Waterproof
- Dimensions: 515 x 55 x 46 (mm)
- Lens: Lexan PC Shatterproof Front Cover
- Chassis: Die-cast Aluminium Alloy
- Finish: Anodised Polyester Powder Coating

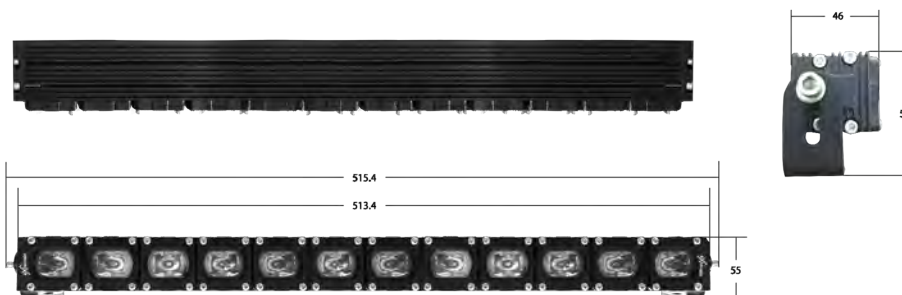
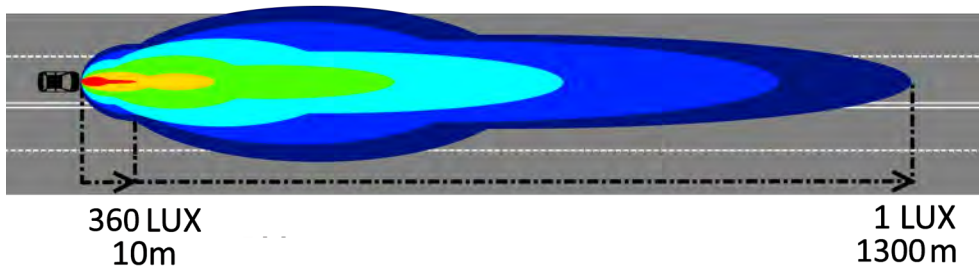



CONDOR270 270mm/11" 30W LED Power

Single Square Row Bar Light



- Spot Beam (45°C)
- 270mm / 11"
- Reverse Polarity Protection
- UV Resistant
- Rust/Corrosion/Freeze Resistant
- Olive Shaped Lens
- Includes Male DT Connector
- Ideal for Cars, 4X4 and Trucks
- LIFETIME WARRANTY
- Voltage: DC10-30V
- Power: 30W (5W x 6) LEDs
- Current: 1.8/0.88A
- Operating Temperature: - 40°C~ 85°C
- Colour Temperature: 6500K
- Luminous Flux: 2550LM
- IP68 Waterproof
- Dimensions: 275 x 55 x 46 (mm)
- Lens: Lexan PC Shatterproof Front Cover
- Chassis: Die-cast Aluminium Alloy
- Finish: Anodised Polyester Powder Coating

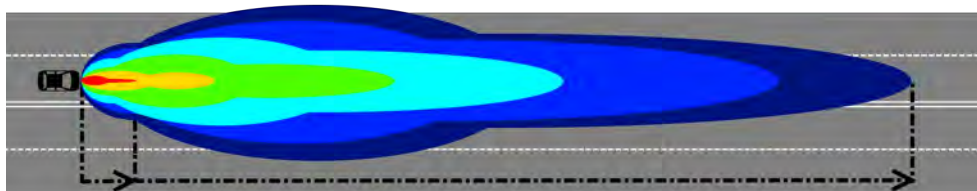

210 LUX
10m

1 LUX
510m





NIGHTOWL RANGE

LED SPOT LIGHTS



eXterrain's Night Owl series are ideal for 4WD and truck installation. These lights range from 50-150 Watt LED power - creating a powerfully bright output for off road conditions.

All eXterrain Raven bar lights come with Lifetime Warranty.

NIGHT OWL 150

9" 150W LED Power

Single Round Spot Light



- Spot Beam (90° + 10°)
- 9 inch
- Reverse Polarity Protection
- UV Resistant
- Rust/Corrosion/Freeze Resistant
- Includes Male DT Connector
- Ideal for Cars, 4X4 and Trucks
- LIFETIME WARRANTY

- Voltage: DC10-30V
- Power: 150W (5W x 30) LEDs
- Current: 5.4/10.8A
- Operating Temperature: - 40°C~ 85°C
- Colour Temperature: 6500K
- Luminous Flux: 12000LM
- IP68 Waterproof
- Dimensions: D220 x H240 x W95 (mm)
- Lens: Lexan PC Shatterproof Front Cover
- Chassis: Die-cast Aluminium Alloy
- Finish: Anodised Polyester Powder Coating

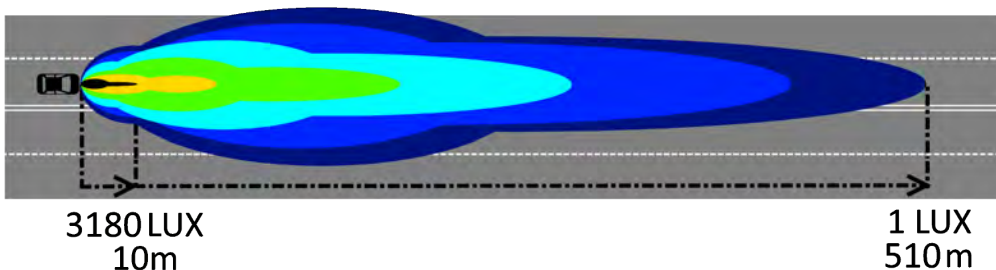
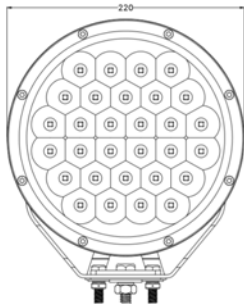

NIGHT OWL 140

9" 140W LED Power

Single Round Spot Light



- Spot Beam (90° + 10°)
- 9 inch
- Reverse Polarity Protection
- UV Resistant
- Rust/Corrosion/Freeze Resistant
- Includes Male DT Connector
- Ideal for Cars, 4X4 and Trucks
- LIFETIME WARRANTY

- Voltage: DC10-30V
- Power: 140W (5W x 24 + 20W x 1) LEDs
- Current: 4.43/8.85A
- Operating Temperature: - 40°C~ 85°C
- Colour Temperature: 6000K
- Luminous Flux: 9476LM
- IP68 Waterproof
- Dimensions: D217 x H243 x W91 (mm)
- Lens: Lexan PC Shatterproof Front Cover
- Chassis: Die-cast Aluminium Alloy
- Finish: Anodised Polyester Powder Coating

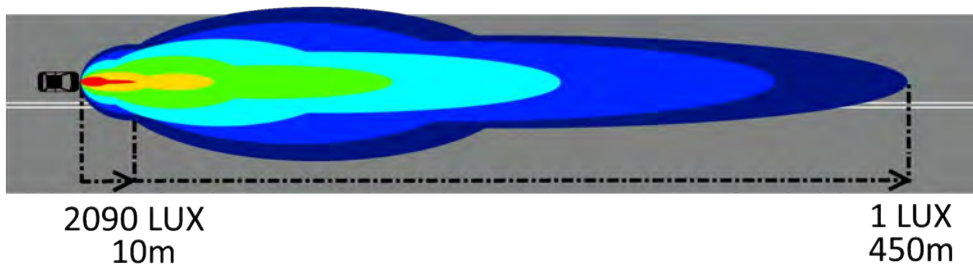
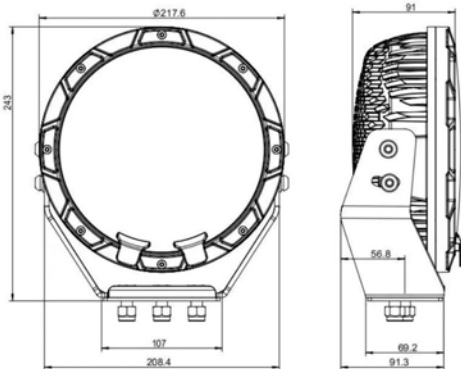

NIGHT OWL 50

7" 50W LED Power

Single Round Spot Light



- Spot Beam (90° + 15°)
- 7 inch
- Reverse Polarity Protection
- UV Resistant
- Rust/Corrosion/Freeze Resistant
- Includes Male DT Connector
- Ideal for Cars, 4X4 and Trucks
- LIFETIME WARRANTY

- Voltage: DC10-30V
- Power: 50W (50W x 1) Luminous LED
- Current: 1.5/2.9A
- Operating Temperature: - 40°C~ 85°C
- Colour Temperature: 6500K
- Luminous Flux: 4250LM
- IP68 Waterproof
- Dimensions: D176 x H205 x W152 (mm)
- Lens: Lexan PC Shatterproof Front Cover
- Chassis: Die-cast Aluminium Alloy
- Finish: Anodised Polyester Powder Coating

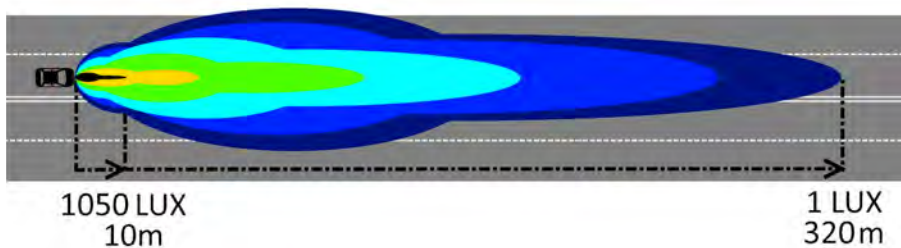
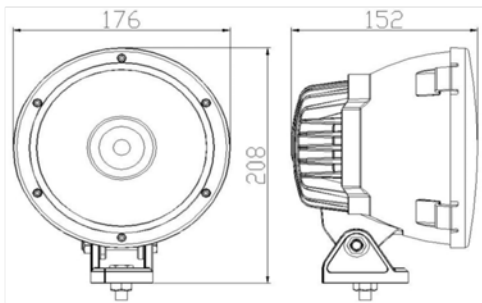



HARRIER AND CANARY RANGE

WORK LIGHTS



eXterrain's engineer light, Harrier and Canary series are ideal for 4WD and truck installation. This range has the option of spot and flood beam—ideal for you to choose the right beam suitable for your application.

All eXterrain Raven bar lights come with Lifetime Warranty.

ENGINEERS LIGHT 100W LED Power

Single Square Flood Light

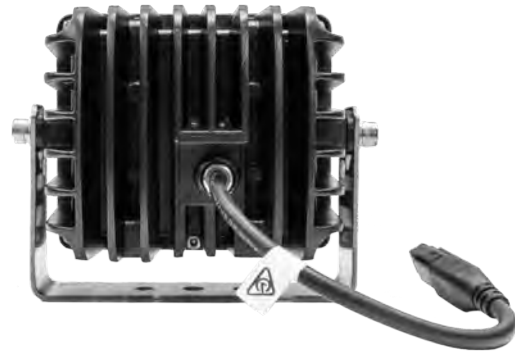

- Flood Beam (90° + 60°)
- Reverse Polarity Protection
- UV Resistant
- Rust/Corrosion/Freeze Resistant
- Includes Male DT Connector
- Ideal for Cars, 4X4 and Trucks
- LIFETIME WARRANTY

- Voltage: DC10-30V
- Power: 100W (5W x 20) LEDs
- Current: 3.5/7.8A
- Operating Temperature: - 40°C~ 85°C
- Colour Temperature: 6500K
- Luminous Flux: 8500LM
- IP68 Waterproof
- Dimensions: D152 x H141 x W115 (mm)
- Lens: Lexan PC Shatterproof Front Cover
- Chassis: Die-cast Aluminium Alloy
- Finish: Anodised Polyester Powder Coating

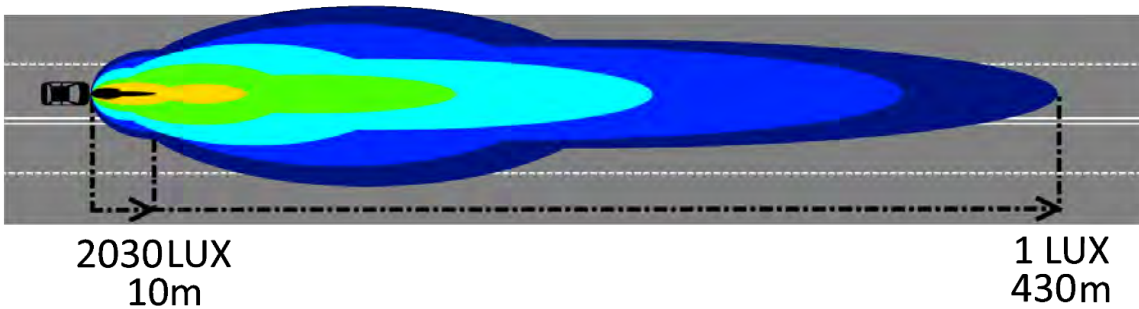
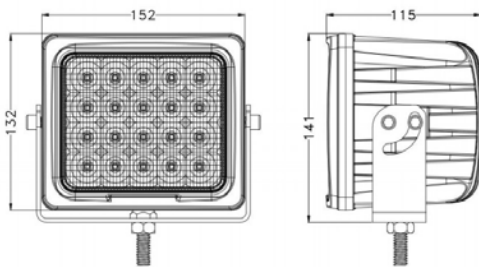

HARRIER50R

4.5" 50W LED Power

Single Round Flood Light



- Flood Beam (90°C + 60°C)
- 4.5 inch
- Reverse Polarity Protection
- UV Resistant
- Rust/Corrosion/Freeze Resistant
- Includes Male DT Connector
- Ideal for Cars, 4X4 and Trucks
- LIFETIME WARRANTY

- Voltage: DC10-30V
- Power: 50W (5W x 10) LEDs
- Current: 1.9/3.8A
- Operating Temperature: - 40°C~ 85°C
- Colour Temperature: 6500K
- Luminous Flux: 4250LM
- IP68 Waterproof
- Dimensions: D109 x H116 x W75 (mm)
- Lens: Lexan PC Shatterproof Front Cover
- Chassis: Die-cast Aluminium Alloy
- Finish: Anodised Polyester Powder Coating

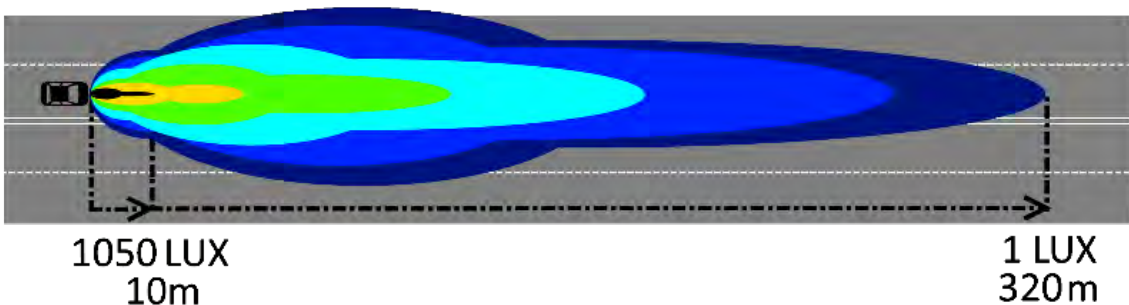
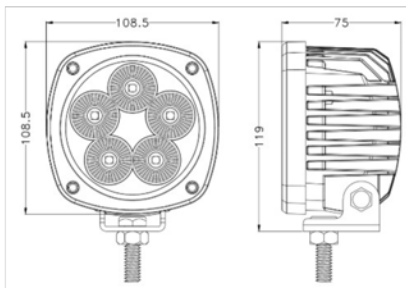

HARRIER40S

4.5" 40W LED Power

Single Rectangle Flood Light



- Flood Beam (90°C + 60°C)
- Reverse Polarity Protection
- UV Resistant
- Rust/Corrosion/Freeze Resistant
- Includes Male DT Connector
- Ideal for Cars, 4X4 and Trucks
- LIFETIME WARRANTY
- Voltage: DC10-30V
- Power: 40W (5W x 8) LEDs
- Current: 1.4/2.8A
- Operating Temperature: - 40°C~ 85°C
- Colour Temperature: 6500K
- Luminous Flux: 3400LM
- IP68 Waterproof
- Dimensions: D150 x H98 x W70 (mm)
- Lens: Lexan PC Shatterproof Front Cover
- Chassis: Die-cast Aluminium Alloy
- Finish: Anodised Polyester Powder Coating

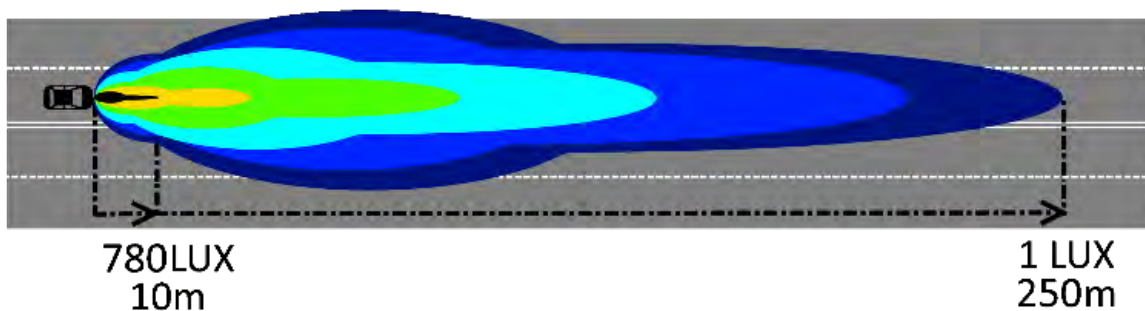
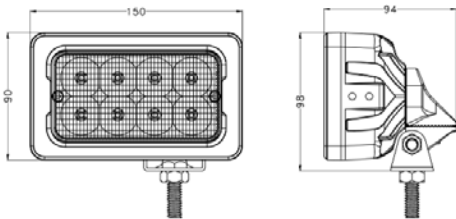

CANARY42 4.5" 42W LED Power

Single Round Spot Light



- Spot Beam (90° + 10°)
- 4.5 inch
- Reverse Polarity Protection
- UV Resistant
- Rust/Corrosion/Freeze Resistant
- Includes Male DT Connector
- Ideal for Cars, 4X4 and Trucks
- LIFETIME WARRANTY

- Voltage: DC10-30V
- Power: 42W (3W x 14) LEDs
- Current: 5.4/10.8A
- Operating Temperature: - 40°C~ 85°C
- Colour Temperature: 6500K
- Luminous Flux: 2520LM
- IP68 Waterproof
- Dimensions: D112 x H126 x W20 (mm)
- Lens: Lexan PC Shatterproof Front Cover
- Chassis: Die-cast Aluminium Alloy
- Finish: Anodised Polyester Powder Coating

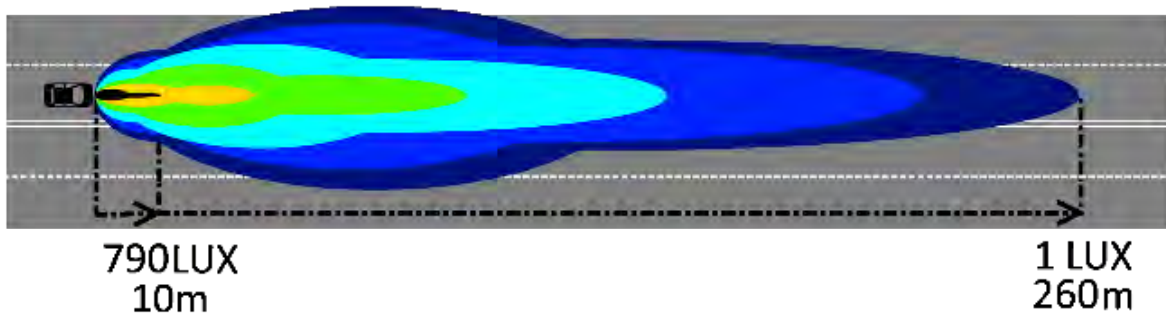
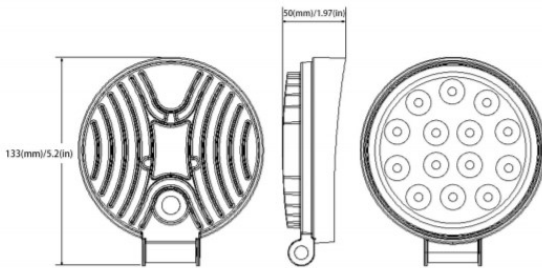

CANARY27

4.5" 27W LED Power

Single Round Spot Light



- Spot Beam (90°C + 10°C)
- 4.5 inch
- Reverse Polarity Protection
- UV Resistant
- Rust/Corrosion/Freeze Resistant
- Includes Male DT Connector
- Ideal for Cars, 4X4 and Trucks
- LIFETIME WARRANTY

- Voltage: DC10-30V
- Power: 27W (3W x 9) LEDs
- Current: 5.4/10.8A
- Operating Temperature: - 40°C~ 85°C
- Colour Temperature: 6500K
- Luminous Flux: 1080LM
- IP68 Waterproof
- Dimensions: D112 x H126 x W39 (mm)
- Lens: Lexan PC Shatterproof Front Cover
- Chassis: Die-cast Aluminium Alloy
- Finish: Anodised Polyester Powder Coating

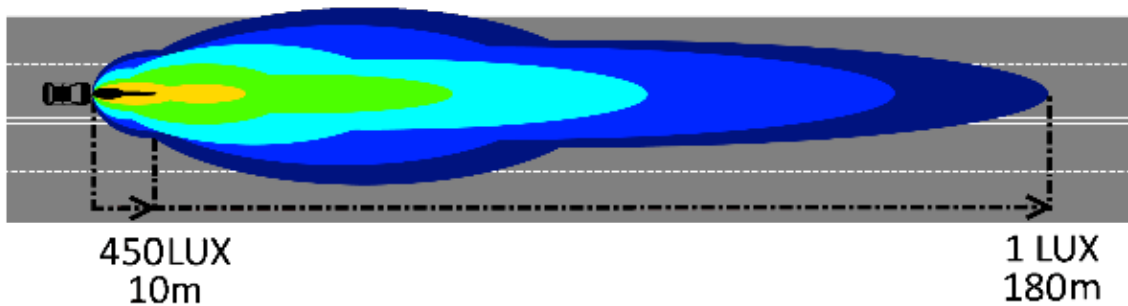
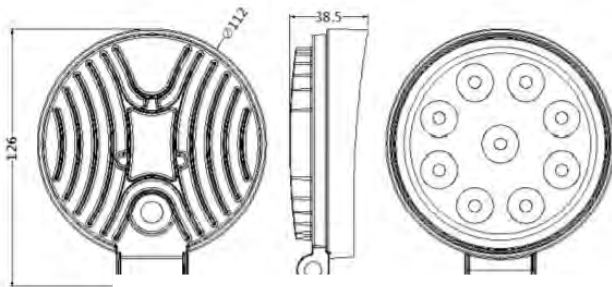

ACCESSORIES

HITCHMOUNT



The Hitchmount is designed to be compatible with most vehicles with a 2" / 50mm hitch receiver. It comes with a lock in bolt—intended to lock the hitch mount on the tow bar and remove play ensuring stability.

- Material: Aluminum
- Finish: Black Powder coated
- Bolt: 20mm long (extra support)
- Diameter of hole for bolt: 8mm
- LIFETIME WARRANTY

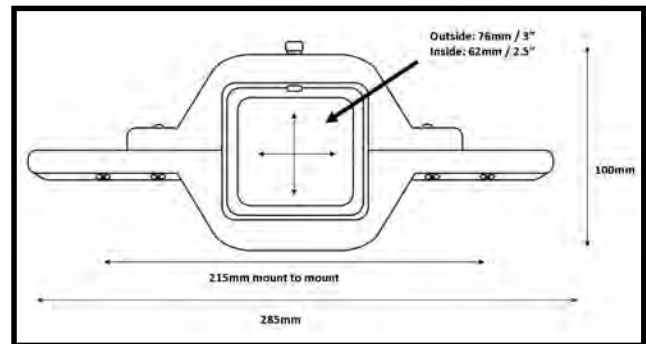

The picture below is an example of use. The eXterrain SDSMount brackets are attached to eXterrain Raven Light Bar series.

Please note: eXterrain's hitch mount is universal and can be used for any light. It is ideally suited for the RAVEN350 or 2 x RavenX80.

Bar light and Slide brackets
sold separately:
not included.

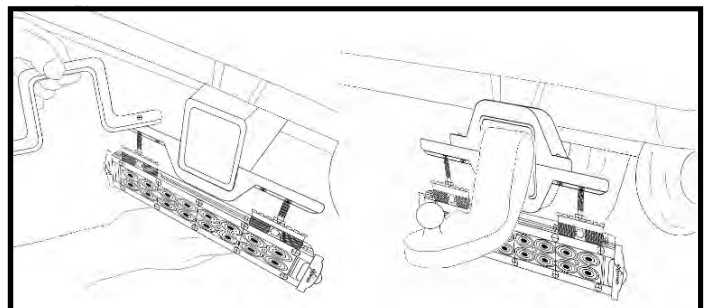
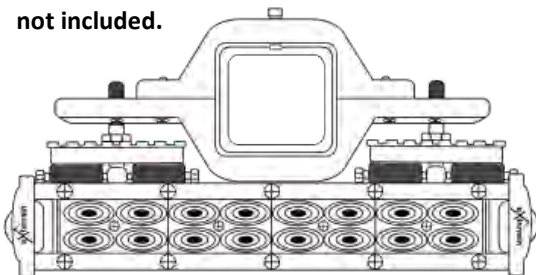

REVERSE LIGHTING

HITCHL24 is designed to be compatible with most vehicles with 2" / 50mm hitch receiver.

FEATURES:

- Voltage: 12V
- Power: 24W 2 x (12 x 1W) LEDs
- Current: 2A
- On/Off Switch
- Reverse Polarity Protection
- Shock Resistant
- Operating Temperature: - 40 ~ 85 °C
- Colour Temperature: 6000K
- IP67 Waterproof
- Includes Lock-in Screw
- Hitch Receiver: 50 x 50 (mm)
- Built-in Connector and Wiring Loom
- Dimensions: 200 x 83 x 73 (mm)
- Material: Plastic
- Finish: Black

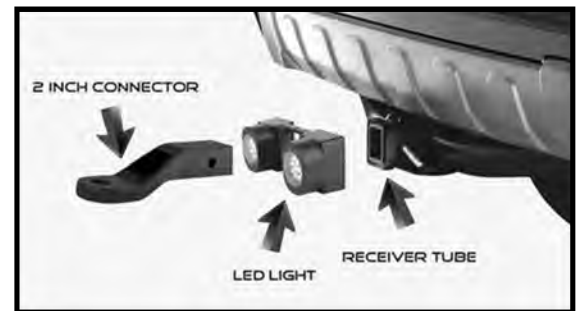
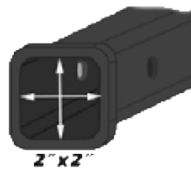
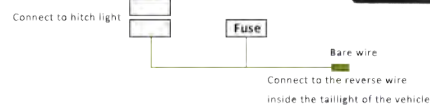
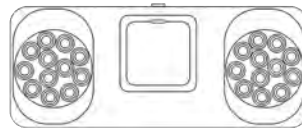

RAVEN350RVP is a reverse pack consisting of 1 x HITCHMOUNT, 1 x RAVEN350, 1 x pair of SDSMOUNT and 1 x LOOM1.

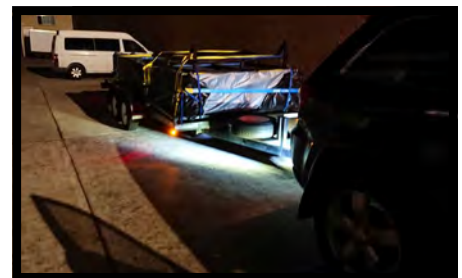

RAVENX80RVP is a reverse pack consisting of 1 x HITCHMOUNT, 2 x RAVENX80, and 1 x LOOM2.

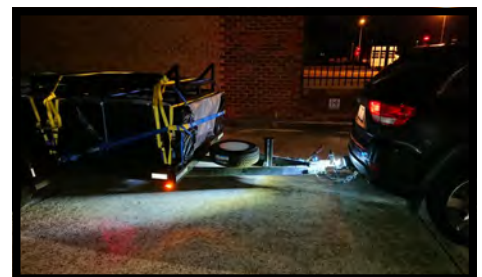

Wiring Loom

Connector & Wiring Information

eXterrain bar and spot lights come with a built-in male DT (or Round connector for high powered lights). If connector is not required, the connector can be cut and hard wired. Also includes wire to optionally connect to high beams. See diagram below.

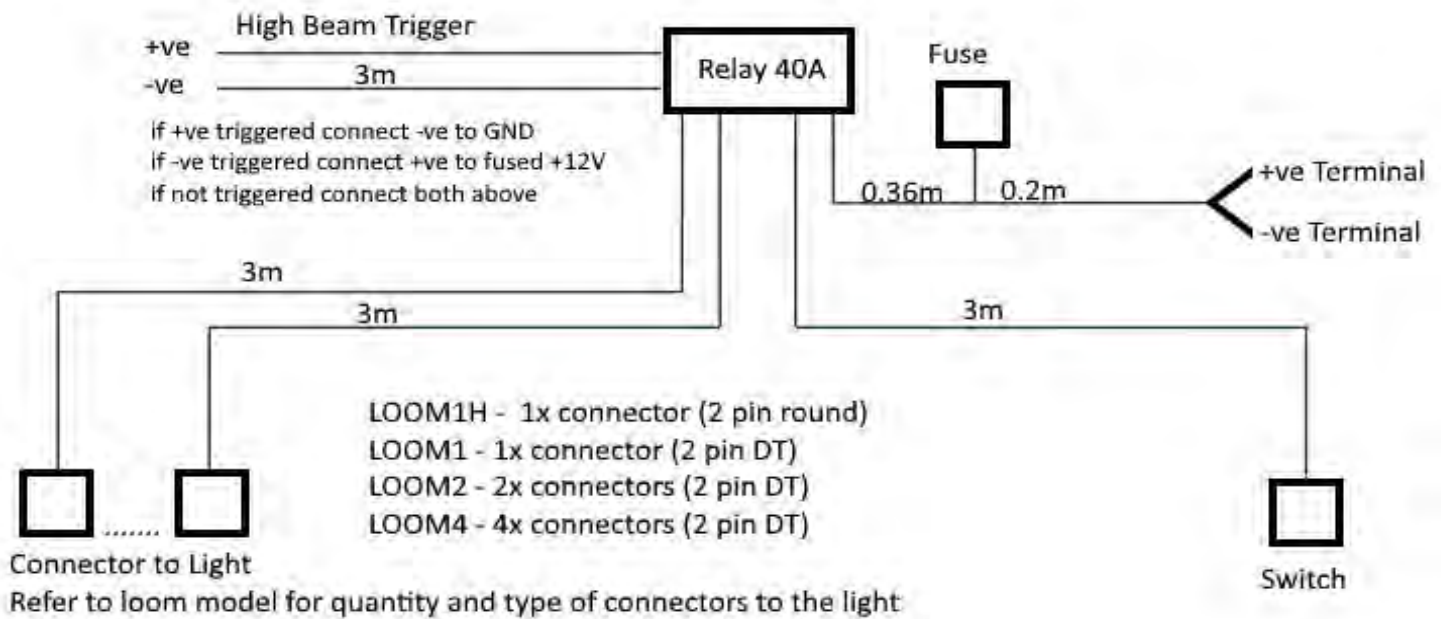

Please note: All loom must be operated on **12 Volt only**—
LOOM1H (MAX 480W), LOOM1 (MAX 180W), LOOM2 (MAX 360W)
AND LOOM4 (MAX 480W).

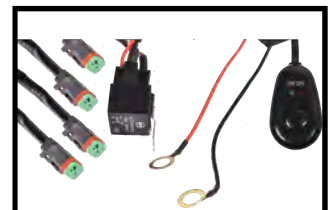
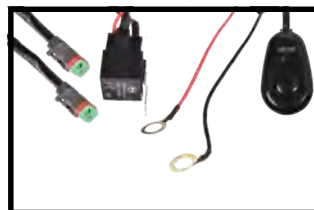
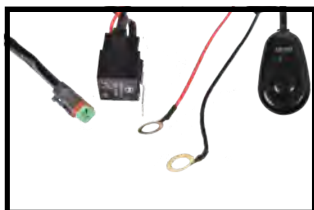

ACCESSORIES

BBB/ : Universal Brackets

eXterrain Universal brackets are suitable for the mounting of lights on tube or bar. Available sizes include:



22mm / 0.875"



25mm / 1"



32mm / 1.25"



38mm / 1.5"



42mm / 1.65"



44mm / 1.75"



50mm / 2"



63mm / 2.5"

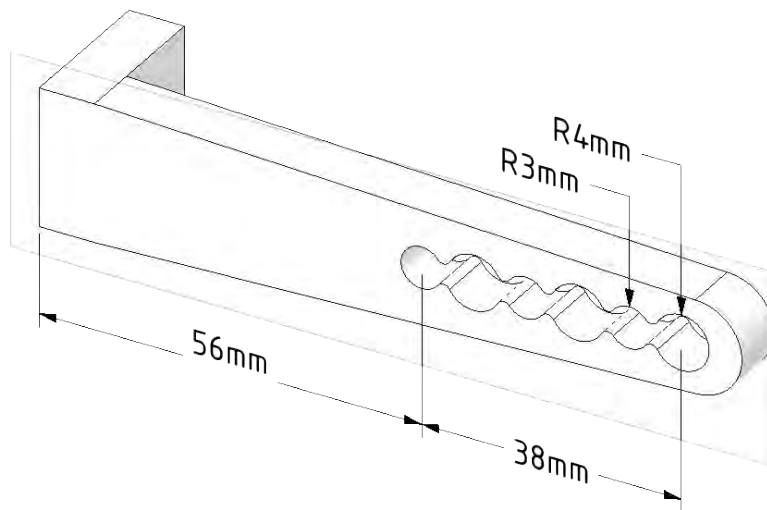

75mm / 3"

ACCESSORIES

BC/ : Open Universal Bar Clamps

eXterrain Open universal bar brackets are suitable for the mounting of lights on tube, roof racks or bars. They are also ideally suited as slide brackets for eXterrain Condor Bar Lights. Available sizes include:



22mm / 0.875"



25mm / 1"



32mm / 1.25"



38mm / 1.5"



42mm / 1.65"



44mm / 1.75"



50mm / 2"



63mm / 2.5"



75mm / 3"

ACCESSORIES

SDSMOUNT: Slide Brackets

eXterrain Slide Brackets - SDSMOUNT can be fitted on the bottom of eXterrain RAVEN Slim Dual LED Bar Lights. These brackets can slide to nearly any position along the light, allowing it to be mounted to a flat surface, spot light mounts or eXterrain's reverse HITCHMOUNT.

The SDSMOUNT uses the M8 bolt—30mm height from the base to bottom of bar light.



SSSMOUNT: Slide Brackets

eXterrain Slide Brackets - SSS MOUNT are fitted by sliding across the top of eXterrain RAVEN S slim single row LED bar lights. These brackets can slide to nearly any position along the light, allowing it to be mounted to a flat surface.





exterrain.com.au